



Pursuing  
The Precision  
Serving  
The World

D01

03  
05  
07  
09  
11  
13  
15  
17  
19  
21  
23  
25

# 带表卡规

## Dial Caliper Gauge

# D

公制带表内卡规

Metric Inside Dial Caliper Gauges

公制带表外卡规

Metric Outside Dial Caliper Gauges

英制带表内卡规

Inch Inside Dial Caliper Gauges

英制带表外卡规

Inch Outside Dial Caliper Gauges

数显卡规

Digital Caliper Gauges



## 数显卡规

Digital Caliper Gauges

## 性能及特点

- 任意位置置零
- 任意位置进行公英制转换
- 置数功能
- 串行输出口可与微机或打印机联接进行数据处理

## FEATURES

- Zeroing at any position
- Metric/inch switching
- Presetting
- Data output can interfacing with a computer or a printer via special converter to process data.



511-605



512-601

## 外形尺寸图 DIMENSIONS(mm)

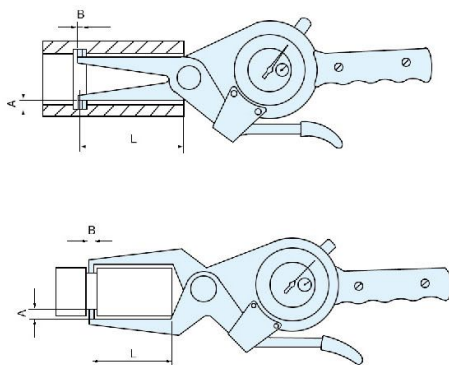

## 主要技术参数 SPECIFICATIONS

货号 Nr.	型号 Model	分度值 Grad.(mm)	测量范围 Range (mm)	外形尺寸(mm)		
				A	B	L
511-603	NKG15-35	0.01	15-35mm	3	∅3	50
511-604	NKG35-55	0.01	35-55mm	6	∅3	80
511-605	NKG55-75	0.01	55-75mm	8	∅3	90
511-606	NKG75-95	0.01	75-95mm	8	∅3.2	100
511-607	NKG95-115	0.01	95-115mm	10	∅3.2	150
511-608	NKG115-135	0.01	115-135mm	10	∅3.2	150
511-609	NKG135-155	0.01	135-155mm	10	∅3.2	200
512-601	WKG0-20	0.01	0-20mm	6	∅3	60
512-602	WKG20-40	0.01	20-40mm	6	∅3	60
512-603	WKG40-60	0.01	40-60mm	6	∅3	55
512-604	WKG60-80	0.01	60-80mm	6	∅3	55
512-605	WKG80-100	0.01	80-100mm	6	∅3	55

D02

04

06

08

10

12

14

16

18

20

22

24

26

## 带表卡规

### DIAL CALIPER GAUGES

#### 公制带表内卡规

#### Metric Inside Dial Caliper Gauges

01

D03

05

07

09

11

13

15

17

19

21

23

25

- 测量范围大于395mm以上的带表内卡规, 可根据用户要求特殊加工。
- 测量范围大于95mm以上内卡规配防震百分表
- The inside dial caliper gauges with measuring range over 395 mm can be made upon request.
- The inside caliper gauge match with shockproof dial indicator above 95mm of measuring range.

外形尺寸图 DIMENSIONS(mm)

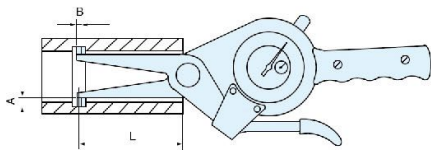

511-103



511-105

#### 主要技术参数 SPECIFICATIONS

货号 Nr.	型号 Model	分度值 Grad.(mm)	测量范围 Range (mm)	外形尺寸(mm)		
				A	B	L
511-102	NKG10-30	0.01	10-30	2.5	∅1.8	50
511-103	NKG15-35	0.01	15-35	3	∅3	50
511-104	NKG35-55	0.01	35-55	6	∅3	80
511-105	NKG55-75	0.01	55-75	8	∅3	90
511-106	NKG75-95	0.01	75-95	8	∅3	100
511-107	NKG95-115	0.01	95-115	10	∅3.2	150
511-108	NKG115-135	0.01	115-135	10	∅3.2	150
511-109	NKG135-155	0.01	135-155	10	∅3.2	200
511-110	NKG155-175	0.01	155-175	10	∅3.2	200
511-111	NKG175-195	0.01	175-195	10	∅3.2	200
511-112	NKG195-215	0.01	195-215	10	∅3.2	200
511-113	NKG215-235	0.01	215-235	10	∅3.2	200
511-114	NKG235-255	0.01	235-255	10	∅3.2	380
511-115	NKG255-275	0.01	255-275	10	∅3.2	380
511-116	NKG275-295	0.01	275-295	10	∅3.2	380
511-117	NKG295-315	0.01	295-315	10	∅3.2	380
511-118	NKG315-335	0.01	315-335	10	∅3.2	200
511-119	NKG335-355	0.01	335-355	10	∅3.2	200
511-120	NKG355-375	0.01	355-375	10	∅3.2	200
511-121	NKG375-395	0.01	375-395	10	∅3.2	200



511-102

## 带表卡规

## DIAL CALIPER GAUGE

## 公制带表外卡规

## Metric Outside Dial Caliper Gauges

02

D04

06

08

10

12

14

16

18

20

22

24

26

- 测量范围大于260mm以上的带表外卡规，可根据用户要求特殊加工。
- 测量范围大于100mm以上外卡规配防震百分表
- The outside dial caliper gauges with measuring rang over 260 mm can be made upon request.
- The outside caliper gauge match with shockproof dial indicator above 100mm of measuring range.



## 主要技术参数 SPECIFICATIONS

货号 Nr.	型号 Model	分度值 Grad.(mm)	测量范围 Range (mm)	外形尺寸(mm)		
				A	B	L
512-101	WKG0-20	0.01	0-20	6	∅3	60
512-102	WKG20-40	0.01	20-40	6	∅3	60
512-103	WKG40-60	0.01	40-60	6	∅3	55
512-104	WKG60-80	0.01	60-80	6	∅3	55
512-105	WKG80-100	0.01	80-100	6	∅3	55
512-106	WKG100-120	0.01	100-120	10	∅3.2	95
512-107	WKG120-140	0.01	120-140	10	∅3.2	95
512-108	WKG140-160	0.01	140-160	10	∅3.2	95
512-109	WKG160-180	0.01	160-180	10	∅3.2	95
512-110	WKG180-200	0.01	180-200	10	∅3.2	95
512-111	WKG200-220	0.01	200-220	10	∅3.2	120
512-112	WKG220-240	0.01	220-240	10	∅3.2	120
512-113	WKG240-260	0.01	240-260	10	∅3.2	120

## 外形尺寸图 DIMENSIONS(mm)

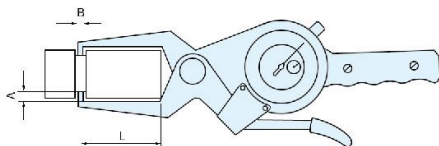

## 带表卡规 DIAL CALIPER GAUGES

英制带表卡规 Inch Dial Caliper Gauges

01

03

D05

07

09

11

13

15

17

19

21

23

25

512-202



### 主要技术参数 SPECIFICATIONS

货号 Nr.	型号 Model	测量范围 Range (in)	分度值 Grad.(in)	外形尺寸(in)		
				A	B	L
512-201	WKG31	0-0.8	0.0005	0.236	0.118	2.3
512-202	WKG32	0.8-1.6	0.0005	0.236	0.118	2.3
512-203	WKG33	1.6-2.4	0.0005	0.236	0.118	2.1
512-204	WKG34	2.4-3.2	0.0005	0.236	0.118	2.1
512-205	WKG35	3.2-4.0	0.0005	0.236	0.118	2.1
512-301	WKG41	0-0.8	0.001	0.236	0.118	2.3
512-302	WKG42	0.8-1.6	0.001	0.236	0.118	2.3
512-303	WKG43	1.6-2.4	0.001	0.236	0.118	2.1
512-304	WKG44	2.4-3.2	0.001	0.236	0.118	2.1
512-305	WKG45	3.2-4.0	0.001	0.236	0.118	2.1

外形尺寸图 DIMENSIONS(in)

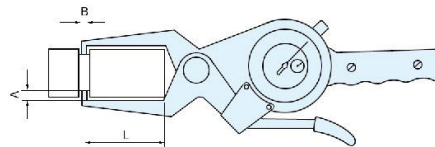

511-304

外形尺寸图 DIMENSIONS(in)

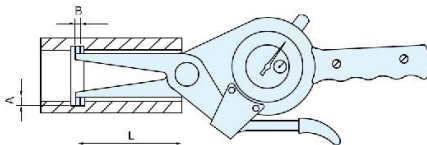

### 主要技术参数 SPECIFICATIONS

货号 Nr.	型号 Model	测量范围 Range (in)	分度值 Grad.(in)	外形尺寸(in)		
				A	B	L
511-203	NKG11	0.6-1.4	0.0005	0.118	0.118	1.9
511-204	NKG12	1.4-2.2	0.0005	0.236	0.118	3.1
511-205	NKG13	2.2-3.0	0.0005	0.315	0.118	3.1
511-206	NKG14	3.0-3.8	0.0005	0.315	0.118	3.9
511-303	NKG21	0.6-1.4	0.001	0.118	0.118	1.9
511-304	NKG22	1.4-2.2	0.001	0.236	0.118	3.1
511-305	NKG23	2.2-3.0	0.001	0.315	0.118	3.1
511-306	NKG24	3.0-3.8	0.001	0.315	0.118	3.9

## 带表卡规 DIAL CALIPER GAUGES

大量程带表外卡规 Dial Caliper Gauges

02  
04  
**D06**  
08  
10  
12  
14  
16  
18  
20  
22  
24  
26



512-401

外形尺寸图 DIMENSIONS(mm)

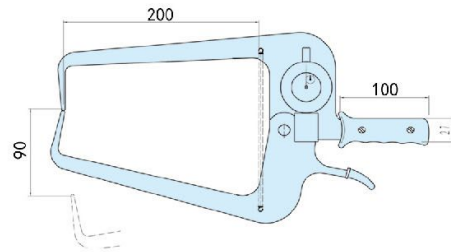

主要技术参数 SPECIFICATIONS

货号	型号	分度值	测量范围
Nr.	Model	Grad.(mm)	Range(mm)
512-401	WKG0-90	0.1	0-90
512-402	WKG0-80	0.1	0-80
512-501	WKG0-50	0.05	0-50

外形尺寸图 DIMENSIONS(mm)

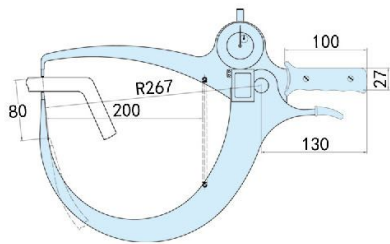

512-402



## 大测深带表内卡规 DIAL CALIPER GAUGES

01  
03  
05  
**D07**  
09  
11  
13  
15  
17  
19  
21  
23  
25

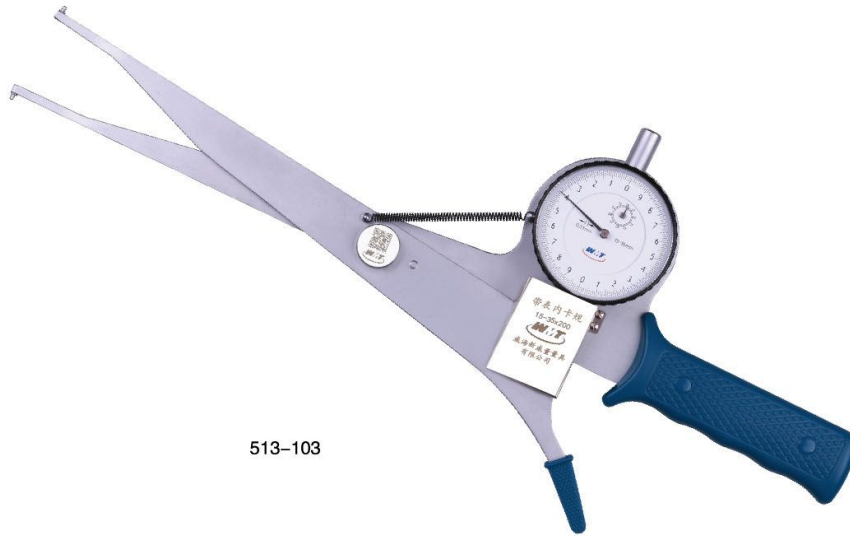

513-103

### 主要技术参数 SPECIFICATIONS

货号 Nr.	型号 Model	分度值 Grad.(mm)	测量范围 Range(mm)	外形尺寸				
				A	B	L		
513-103	NKG15-35	0.01	15-35	3	Φ3	160	200	250
513-104	NKG35-55	0.01	35-55	13	Φ3	160	250	200
513-105	NKG55-75	0.01	55-75	8	Φ3	200	250	

### 外形尺寸图 DIMENSIONS(mm)

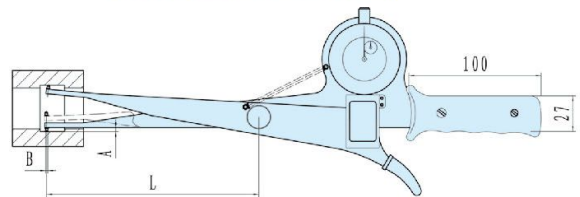

## 快速卡规 External Quick Caliper



514-101

### 主要技术参数 SPECIFICATIONS

货号 Nr.	型号 Model	分度值 Grad.(mm)	测量范围 Range(mm)
514-101	WKG0-10	0.1	10

### 外形尺寸图 DIMENSIONS(mm)

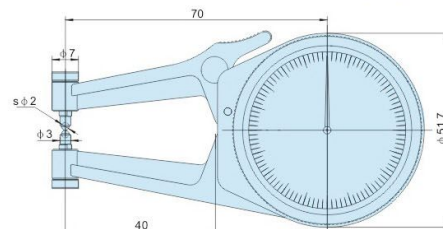

## 带可换测头的高精度内卡规

### DIAL CALIPER GAUGES WITH REPLACEABLE ANVILS

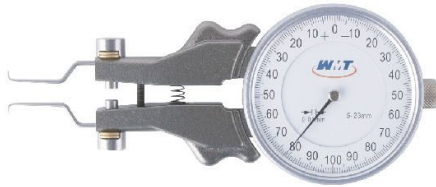

515-102

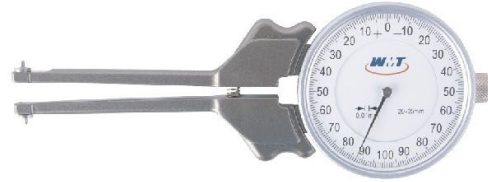

515-103



515-105

### 外形尺寸图 DIMENSIONS(mm)

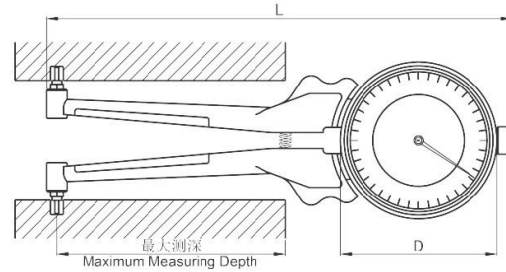

### 附件图 Accessory Figure

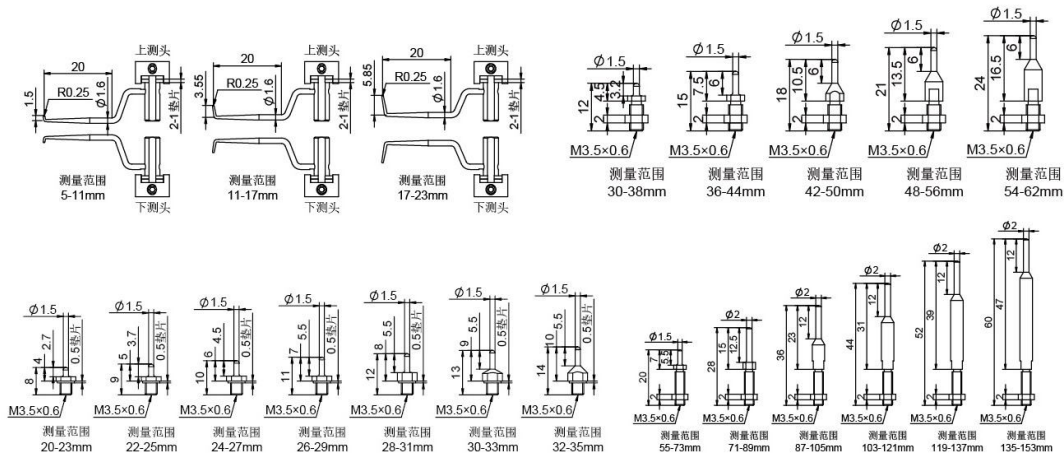

### 主要技术参数 SPECIFICATIONS

货号 Nr.	型号 Model	分度值 Grad.(mm)	测量范围 Range(mm)	精度指标 Accuracy(mm)	测量深度 Measuring depth(mm)	可换测头 Anvils(pair)	外形尺寸 L D
515-102	NKG5-23	0.01	5-23	0.02	20	3	150 Φ62
515-103	NKG20-35	0.01	20-35	0.02	70	7	168 Φ62
515-104	NKG30-62	0.01	30-62	0.02	75	5	172 Φ62
515-105	NKG55-153	0.01	55-153	0.02	90	6	183 Φ62

02  
04  
06  
**D08**  
10  
12  
14  
16  
18  
20  
22  
24  
26